

PORTUGUÊS

1. RECOMENDAÇÕES

- Antes de proceder à instalação, leia atentamente o conteúdo do presente manual. Ele pretende fornecer toda a informação necessária para a instalação, uso e manutenção das bombas MB.
- É importante que o utilizador leia este manual antes de usar a bomba.
- Os danos provocados na electrobomba, pelo não cumprimento das indicações descritas a seguir, obrigam à perda da garantia.

- No momento da recepção da electrobomba, verifique se esta não sofreu danos durante o transporte.
- Neste caso, alerte imediatamente o nosso agente.

2. CONDIÇÕES DE FUNCIONAMENTO:

- São bombas centrífugas concebidas para trabalharem com água limpa, com temperatura máxima de 40°C

3. INSTALAÇÃO:

- A bomba deve fixar-se a uma base sólida mediante parafusos, aproveitando os orifícios existentes nas patas do motor, com o objectivo de evitar ruídos e vibrações indesejáveis.
- Deve colocar-se o mais próximo possível do nível da água a fim de obter altura de aspiração mínima e reduzir as perdas de carga.

- Deve procurar-se que esteja a salvo de possíveis inundações e em lugar ventilado e seco.

4. MONTAGEM DOS TUBOS:

- A tubagem de aspiração (Fig.1) deve ter um diâmetro igual ou superior ao orifício de entrada da bomba, conservando uma inclinação ascendente de pelo menos 2%, para facilitar a purga.
- É imprescindível a colocação de uma válvula de pé, com filtro, submersa pelo menos 30 cm abaixo do nível dinâmico do poço, para evitar remoinhos e consequentes entradas de ar.
- Procure que a tubagem de compressão (Fig. 1) tenha um diâmetro igual ou superior ao orifício de saída da bomba.
- Nem a tubagem de aspiração nem de compressão devem ficar suspensas da bomba.

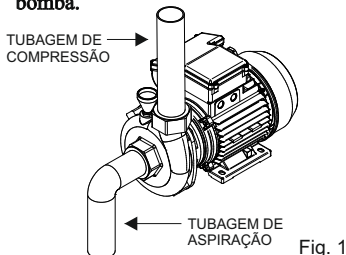

5. LIGAÇÃO ELÉCTRICA:

- Os motores monofásicos têm protecção térmica incorporada.
- A instalação eléctrica deverá dispor de um sistema de separação múltipla com abertura de contactos de pelo menos 3mm.

MB

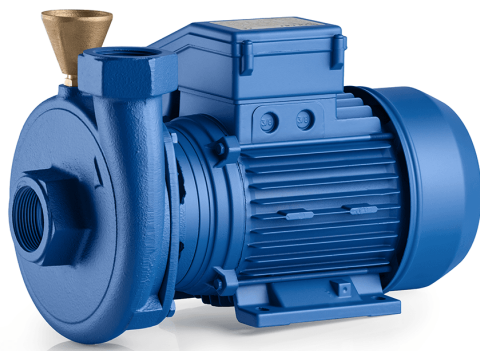

CE

Instruções para uso e dados técnicos
Instructions for use and technical data



PORTUGUÊS

- A protecção do sistema basear-se-á num interruptor diferencial (IFN= 30 ma). O cabo de alimentação deve corresponder à norma CEE (2) ou ao tipo H07 RNF.

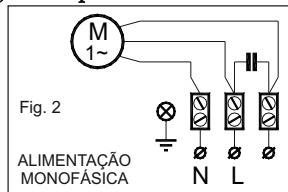

- No caso das bombas trifásicas a protecção deve ser prevista pelo utilizador segundo as normas de instalação vigentes.
- Os esquemas da Fig.3 facilitam a correcta ligação eléctrica.

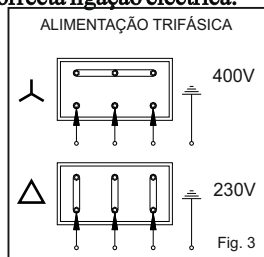

6. CONTROLES PRÉVIOS AO ARRANQUE INICIAL:

- Comprove que a tensão e frequência de rede correspondem às indicadas na placa de características.

6. CONTROLES PRÉVIOS AO ARRANQUE INICIAL:

- Comprove que a tensão e frequência de rede correspondem às indicadas na placa de características.
- Assegure-se de que o veio do motor roda livremente.
- Encha completamente de água o corpo da bomba e a tubagem de aspiração, através do bujão de ferragem (Fig. 4), assegurando-se de que não existe nenhuma junta ou união com fugas.

7. ARRANQUE

- Verifique se o sentido de rotação do motor coincide com o indicado na tampa do ventilador. Na versão monofásica o sentido já é predefinido. Nos motores trifásicos, se o sentido de rotação estiver errado, inverta duas fases no quadro de protecção.

A BOMBA NUNCA DEVE FUNCIONAR EM SECO.

7. ARRANQUE

- Abra todas as válvulas de secionamento que existam nos circuitos de aspiração e com-pressão.
- Verifique a corrente absorvida e ajuste o relé térmico (apenas na versão trifásica).
- Se o motor não funcionar ou não extrair água, procure descobrir a anomalia através da relação das avarias mais habituais e as suas possíveis resoluções, que facultamos no quadro em baixo.

8. MANUTENÇÃO

- As nossas bombas não necessitam de nenhuma manutenção específica ou programada.

Recomenda-se, no entanto, que se esvazie o corpo da bomba durante os períodos de baixas temperaturas ou em caso de inactividade prolongada, através do bujão de purga (Fig. 5). Se a inactividade persistir durante muito tempo, deve limpar-se a bomba e guardá-la em lugar seco e ventilado.

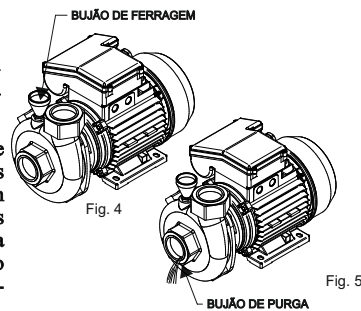

8. AVARIAS E CAUSAS



Antes de tentar diagnosticar qualquer avaria, verifique se a alimentação eléctrica foi desligada.

AVARIA	CAUSA POSSÍVEL
O bomba não arranca.	<ul style="list-style-type: none"> - Falha na corrente de energia. - Circuito de controlo está desligado ou defeituoso. - Motor defeituoso. - Bomba bloqueada devido a impurezas.
A bomba trabalha mas não sai água.	<ul style="list-style-type: none"> - A bomba não está ferrada. - Tubos de aspiração ou descarga bloqueados devido a impurezas. - Excesso de altura de aspiração. - Fuga no tubo de aspiração. - Válvula de pesca/retenção bloqueada.
A bomba funciona a capacidade reduzida.	<ul style="list-style-type: none"> - Sentido de rotação errado (trifásica). - Excesso de altura de elevação. - Tubos de aspiração ou descarga bloqueados ou defeituosos. - Bomba bloqueada devido a impurezas. - Válvula de pesca ou retenção parcialmente bloqueada.
A bomba para durante o funcionamento.	<ul style="list-style-type: none"> - O interruptor térmico do motor ou da protecção exterior do motor desliga. - Circuito de controlo está desligado.

Se o problema persistir contacte o serviço de assistência técnica mais próximo.

ENGLISH

1. GENERAL WARNINGS

- Read this manual carefully before installing this pump. It contains every necessary information for installation, correct use and maintenance of MB pumps.

- It's very important that the user reads this manual before using the pump. Any damage caused by failure to observe the directions contained in this manual will not be covered by warranty.

! - By the time you receive this pump check if it wasn't damaged during transportation.

- In this case, please contact our agent as soon as possible.

2. OPERATING CONDITIONS:

- The MB are centrifugal pumps and have been designed to work with clean water at a maximum temperature of 40°C.

3. INSTALLATION:

- The pump should be fixed to a solid base by bolts through the holes in the pump bracket in order to prevent unwanted noise or vibration.

! - You should place pump as near as possible to water level so to have the minimum suction lift and reduce loss of head.

- Make sure that pump is never submerged and that it rests in a dry and well aired room.

4. PIPES ASSEMBLY:

- Suction pipe (Pic. 1) must have a slightly larger diameter than the pump inlet and must always remain in an upward inclination of 2% so to help with correct priming.

- A foot valve with filter should be installed and submerged to at least 30 cm below the well dynamic level to prevent air from entering the pump.

- Be sure that discharge pipe (Pic. 1) should never rest on top of the pump.

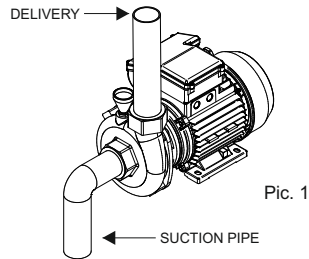

5. ELECTRICAL CONNECTION:

- The single-phase motors have a built-in thermal protection.

- The electrical installation must have a system of multiple separations with contact opening of at least 3 mm.

- The protection of the system will be based on a differential switch (I_{fn} = 30 ma).

- The electric cable must correspond to the EEC (2) norm or to the type H07 RN-F.

- With three-phase motors, end-user must install himself the correct protection to the pump as per the appropriate installation regulations.

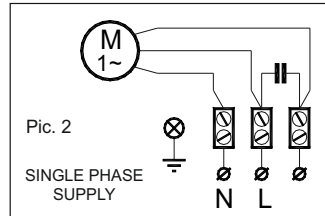

ENGLISH

- Follow directions on Pic. 3 for a correct electrical connection.

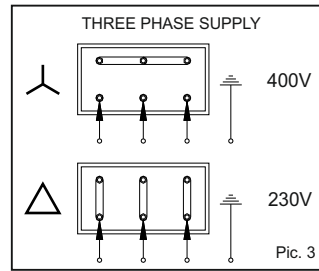

- Check absorbed current and adjust thermal relay conveniently only when operating with three-phase pumps.

- If motor failed to start or did not pump water up, refer to our "Trouble Shooting" list and identify your problem. Then follow instruction on what action to take.

8. MAINTENANCE

- Our pumps do not need any special or programmed maintenance.

Pump body should, however, be drained during periods of low temperatures or long periods of inactivity. To empty pump, only remove drain plug (Pic. 5). If the inactivity persisted, pump should be cleaned and stored in a dry aired room

6. CONTROLS PRIOR TO THE INITIAL STARTING:

- Check that voltage and frequency correspond to those indicated on the technical characteristics label.

- Make sure the motor shaft is turning freely.

- Fill pump body completely with water, as well as the suction pipe, through the priming hole (Pic. 4). Check that there is no leaking through joints or connections.

- Check to assure that the sense of rotation of the motor coincides with that indicated on the fan cover. If you are checking threephase motor and the sense of rotation is wrong, invert two phases on the protection board.

THIS PUMP SHOULD NEVER BE DRY OPERATED.

7. STARTING

- Open all gate valves installed in the suction and discharge circuits.

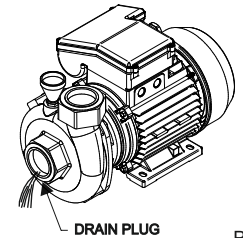
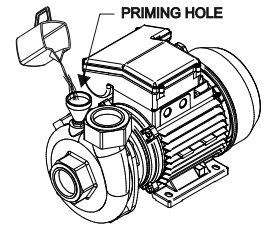

ENGLISH

9. FAULT FINDING CHART

! Before attempting to diagnose any fault, make sure that the electricity supply has been switched off.

FAULT	CAUSE
Pump does not start.	<ul style="list-style-type: none"> - Supply failure. - Control circuit has cut out or is defective. - Motor is defective. - Pump is blocked by impurities.
Pump runs but gives no water.	<ul style="list-style-type: none"> - Pump is not filled with liquid. - Suction or discharge pipe is blocked by impurities. - Pump is blocked by impurities. - Suction lift is too great. - Leakage in suction pipe. - Foot or non-return valve is blocked.
Pump runs at reduced capacity.	<ul style="list-style-type: none"> - Wrong direction of rotation (three-phase). - Suction lift is too great. - Suction or discharge pipe is blocked. - Pump is blocked by impurities. - Foot or non-return valve is partly blocked.
Pump stops during operation.	<ul style="list-style-type: none"> - Thermal overload switch in motor or external motor protection cuts out. - Control circuit has cut out.

If in spite of carrying out the above operations the problem still persists contact the nearest service centre.

The products, referred to in this statement are in accordance with Directive 73/23/EEC (the Low Voltage Directive). Full compliance with essential requirements of the Directive is verified for compliance with standard EN 60335-2-41.

As electrobombas referidas nesta declaração, estão em conformidade com a Directiva 73/23/CEE (Directiva de Baixa Tensão). A plena concordância com os requisitos essenciais da Directiva é comprovada pela conformidade com a norma **EN 60335-2-41.**

Rodriguez
(Gerente)

1-RECOMENDACIONES

- Antes de proceder a su instalación, leer atentamente el contenido de este manual. Con ello damos a conocer toda la información necesaria para su instalación, uso y mantenimiento de las electrobombas MB.
- Es importante que el instalador preste atención a este manual, antes de usar la electrobomba.
- Los daños que se produzcan por no cumplir las indicaciones, evitarán las correspondientes garantías.

! En el momento de recibir la electrobomba, verificar si pudo haber sufrido daños durante el transporte.

- En este caso comunicar de inmediato a la agencia transportista, así como al proveedor.

2. CONDICIONES DE FUNCIONAMIENTO:

- Son bombas centrífugas concebidas para trabajar con aguas limpias de temperatura máxima 40°C.

3. INSTALACIÓN:

- La bomba debe fijarse a una base sólida mediante tornillos aprovechando los agujeros del soporte con objeto de evitar ruidos y vibraciones indeseables.

- Se colocará lo más cerca posible del nivel del agua a fin de obtener el mínimo recorrido de aspiración y la reducción de las pérdidas de carga.

- Se procurará que esté a salvo de posibles inundaciones y reciba una ventilación de carácter seco.

4. MONTAJE DE TUBERÍAS:

- La tubería de aspiración (Fig. 1) debe poseer un diámetro igual o superior al de la

boca de entrada de la bomba permanentemente una pendiente ascendente mínima del 2% para que contribuya a efectuar una purga correcta.

- Es imprescindible una colocación de una válvula de pie con su filtro pertinente sumergida por los menos de 30 cm por debajo del nivel dinámico del pozo con lo que se evitarán remolinos y consecuentes entradas de aire.

- Procure que la tubería de impulsión (Fig. 1) posea un diámetro igual o superior al de la boca de impulsión

- Ni la tubería de aspiración ni la de impulsión deben descansar sobre la bomba.

- Al emplear un diámetro superior en las tuberías se estructurarán con sus correspondientes conos excéntricos en la aspiración y concéntricos en la impulsión.

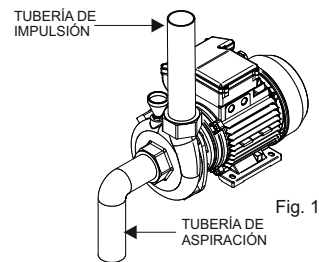

Fig. 1

5. CONEXIÓN ELÉCTRICA:

- Los motores monofásicos llevan protección térmica incorporada.

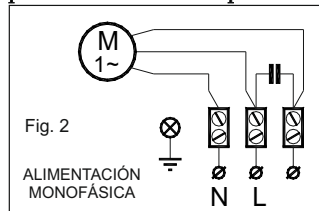
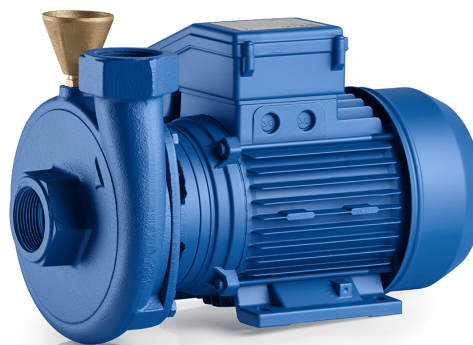

Fig. 2

ALIMENTACIÓN MONOFÁSICA



Instrucciones de instalación



- La instalación eléctrica deberá disponer de un sistema de separación múltiple con aperturas de contactos de al menos de 3 mm.

- La protección del sistema se basará en un interruptor diferencial (I_{fn} = 30 ma.). El cable de alimentación debe corresponder a la norma CEE (2) o bien al tipo H07 RN-F según VDE 0250.

- En el caso de los trifásicos, el usuario debe proveer a la misma según las normas de instalación vigentes.

- Los esquemas de la figura 3 facilitan una correcta conexión eléctrica.

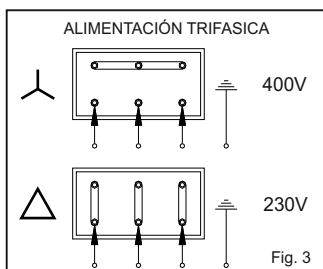

Fig. 3

6. CONTROLES PREVIOS A LA PUESTA EN MARCHA INICIAL:

- Compruebe que la tensión y frecuencia de la red corresponden a las indicadas en la placa de características.

- Asegúrese de que el eje del motor gire libremente.

- Llene de agua completamente el cuerpo bomba al igual que el tubo de aspiración a través del tapón de cebado (Fig. 4), asegurándose de que no exista ninguna junta o racord con pérdidas

- Compruebe que el sentido de giro del motor coincida con el indicado en el tapón de ventilador. En los motores trifásicos, si el sentido de giro es erróneo invierta dos fases en el cuadro de protección.

LA BOMBA NO DEBE FUNCIONAR NUNCA EN SECO.

7. PUESTA EN MARCHA

- Abra todas las válvulas de compuerta que existan en los circuitos de aspiración e impulsión.

- Compruebe la corriente absorbida y ajuste debidamente el relé térmico sólo en el caso de la versión trifásica.

- Si el motor no funcionara o no extrajera agua procure descubrir la anomalía a través de la relación de averías más habituales y sus posibles resoluciones que facilitamos en páginas posteriores.

8. MANTENIMIENTO

- Nuestras bombas no necesitan de ningún mantenimiento específico o programado. Se recomienda sin embargo vaciar el cuerpo bomba durante los periodos de bajas temperaturas o en caso de inactividad prolongada a través del tapón de purga (Fig. 5). Si la inactividad persistiera, debe limpiarse la bomba y aguardarse en lugar seco y ventilado.

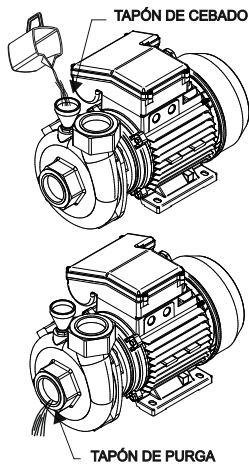

Fig. 4

Fig. 5

9. LOCALIZACIÓN DE FALLOS



Antes de intentar diagnosticar un fallo, comprobar que el suministro eléctrico está desconectado.

FALLO	CAUSA
La bomba no arranca.	<ul style="list-style-type: none"> - Fallo del suministro eléctrico. - El circuito de control se ha disparado o está defectuoso. - La bomba está defectuosa. - La bomba está bloqueada por impurezas.
La bomba funciona pero no da agua.	<ul style="list-style-type: none"> - La bomba no está llena de líquido. - La tubería de aspiración o de descarga está bloqueada por impurezas. - La bomba está bloqueada por impurezas. - La altura de aspiración es demasiado grande. - Hay fugas en la tubería de aspiración. - La válvula de pie o de retención está bloqueada.
La bomba funciona a capacidad reducida.	<ul style="list-style-type: none"> - Sentido de giro contrario (trifásica). - La altura de aspiración es demasiado grande. - La tubería de aspiración o de descarga está bloqueada. - La bomba está bloqueada por impurezas. - La válvula de pie o de retención está parcialmente bloqueada.
La bomba para durante su funcionamiento.	<ul style="list-style-type: none"> - Se dispara el térmico del motor o la protección externa. - El circuito de control se ha disparado.

Si el problema persistir contacte el servicio de asistencia técnica más próximo.

ENGLISH

1. GENERAL WARNINGS

- Read this manual carefully before installing this pump. It contains every necessary information for installation, correct use and maintenance of MB pumps.

- It's very important that the user reads this manual before using the pump. Any damage caused by failure to observe the directions contained in this manual will not be covered by warranty.

! - By the time you receive this pump check if it wasn't damaged during transportation.

- In this case, please contact our agent as soon as possible.

2. OPERATING CONDITIONS:

- The MB are centrifugal pumps and have been designed to work with clean water at a maximum temperature of 40° C.

3. INSTALLATION:

- The pump should be fixed to a solid base by bolts through the holes in the pump bracket in order to prevent unwanted noise or vibration.

! - You should place pump as near as possible to water level so to have the minimum suction lift and reduce loss of head.

- Make sure that pump is never submerged and that it rests in a dry and well aired room.

4. PIPES ASSEMBLY:

- Suction pipe (Pic. 1) must have a slightly larger diameter than the pump inlet and must always remain in an upward inclination of 2% so to help with correct priming.

- A foot valve with filter should be installed and submerged to at least 30 cm below the well dynamic level to prevent air from entering the pump.

- Be sure that discharge pipe (Pic. 1) should never rest on top of the pump.

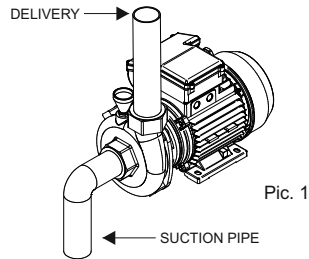

5. ELECTRICAL CONNECTION:

- The single-phase motors have a built-in thermal protection.

- The electrical installation must have a system of multiple separations with contact opening of at least 3 mm.

- The protection of the system will be based on a differential switch (I_{fn} = 30 ma).

- The electric cable must correspond to the EEC (2) norm or to the type H07 RN-F.

- With three-phase motors, end-user must install himself the correct protection to the pump as per the appropriate installation regulations.

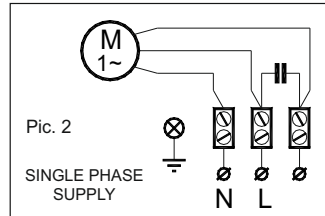

- Follow directions on Pic. 3 for a correct electrical connection.

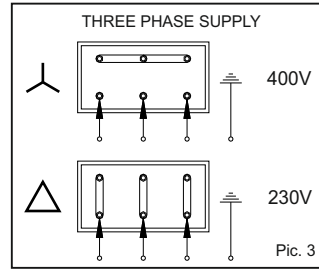

6. CONTROLS PRIOR TO THE INITIAL STARTING:

- Check that voltage and frequency correspond to those indicated on the technical characteristics label.

- Make sure the motor shaft is turning freely.

- Fill pump body completely with water, as well as the suction pipe, through the priming hole (Pic. 4). Check that there is no leaking through joints or connections.

- Check to assure that the sense of rotation of the motor coincides with that indicated on the fan cover. If you are checking threephase motor and the sense of rotation is wrong, invert two phases on the protection board.

THIS PUMP SHOULD NEVER BE DRY OPERATED.

7. STARTING

- Open all gate valves installed in the suction and discharge circuits.

- Check absorbed current and adjust thermal relay conveniently only when operating with three-phase pumps.

- If motor failed to start or did not pump water up, refer to our "Trouble Shooting" list and identify your problem. Then follow instruction on what action to take.

8. MAINTENANCE

- Our pumps do not need any special or programmed maintenance.

Pump body should, however, be drained during periods of low temperatures or long periods of inactivity. To empty pump, only remove drain plug (Pic. 5). If the inactivity persisted, pump should be cleaned and stored in a dry aired room

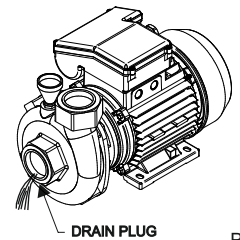
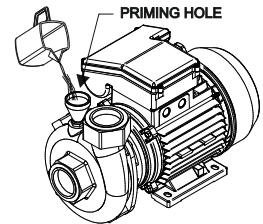

ENGLISH

9. FAULT FINDING CHART

! Before attempting to diagnose any fault, make sure that the electricity supply has been switched off.

FAULT	CAUSE
Pump does not start.	<ul style="list-style-type: none"> - Supply failure. - Control circuit has cut out or is defective. - Motor is defective. - Pump is blocked by impurities.
Pump runs but gives no water.	<ul style="list-style-type: none"> - Pump is not filled with liquid. - Suction or discharge pipe is blocked by impurities. - Pump is blocked by impurities. - Suction lift is too great. - Leakage in suction pipe. - Foot or non-return valve is blocked.
Pump runs at reduced capacity.	<ul style="list-style-type: none"> - Wrong direction of rotation (three-phase). - Suction lift is too great. - Suction or discharge pipe is blocked. - Pump is blocked by impurities. - Foot or non-return valve is partly blocked.
Pump stops during operation.	<ul style="list-style-type: none"> - Thermal overload switch in motor or external motor protection cuts out. - Control circuit has cut out.

If in spite of carrying out the above operations the problem still persists contact the nearest service centre.

The products, referred to in this statement are in accordance with Directive 73/23/EEC (the Low Voltage Directive). Full compliance with essential requirements of the Directive is verified for compliance with standard EN 60335-2-41.

Les produits, visés dans la présente déclaration sont conformes à la directive 73/23/CEE (la Directive Basse Tension). Plein respect des exigences essentielles de la directive est vérifié pour la conformité à la norme EN 60335-2-41.

Rodriguez
(Généralist)

FRANÇAIS

1. AVERTISSEMENT:

- Avant d'installer cette pompe, veuillez lire attentivement ce manuel. Il contient toute information nécessaire pour l'installation, l'utilisation et l'entretien corrects des pompes BMI/BTI.
- Il est très important que l'utilisateur lise ce manuel avant utilisation de la pompe.
- Tout dommage, découlant de la non observation des instructions décrites dans ce manuel, ne sera pas couvert par la garantie.

! - Dès réception de la pompe vérifier qu'elle n'a pas été abîmée pendant le transport.

- En cas de dommage contacter votre fournisseur aussitôt.

2. LIMITES D'UTILISATION:

- Les pompes centrifuges sont conçues pour travailler avec des eaux propres et à une température de 40°C maxi.

3. INSTALLATION:

- La pompe doit être fixée sur une base solide au myen des orifices situés dans le pied support afin d'éviter des bruits et vibrations ennuyeux.

! Elle doit être positionnée le plus près possible du niveau de l'eau pour obtenir un parcours minimal d'aspiration, réduisant ainsi les pertes de charge.

- Elle devront être installées dans des endroits secs et à l'abri d'éventuelles inondations.

4. POSE DES TUYAUX:

- Le tuyau d'aspiration (Fig. 1) doit être d'un diamètre égal ou supérieur à l'orifice d'aspiration de la pompe, et maintenir une pente ascendante d'au moins 2% pour permettre une bonne purge de la tuyauterie.
- Il est nécessaire d'installer un clapet de pied crépine immergé au moins 30 cm

sous le niveau de l'eau pour éviter les turbulences entraînant l'entrée d'air.

- Le tuyau de refoulement (Fig. 1) doit avoir un diamètre égal ou supérieur à celui de l'orifice de refoulement de la pompe.
- En aucun cas les tuyaux d'aspiration ou de refoulement ne devront produire d'efforts mécaniques sur la pompe.
- Lors de emploi d'un tuyau de diamètre supérieur, il est nécessaire de placer des cônes diffuseurs adaptés.

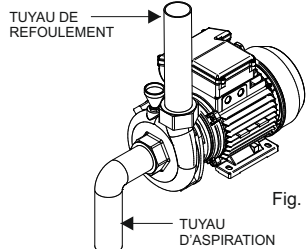

Fig. 1

5. BRANCHEMENT ELECTRIQUE:

- L'installation électrique devra être munie d'un système séparateur multiple avec ouverture de contacts d'au moins 3mm.
- La protection du système sera fondée sur interrupteur différentiel (I_{fn} = 30 ma).
- Le câble d'alimentation doit être conforme, soit à la norme CEE (2), soit au type H07 RNF, suivant VDE 0250.
- Les moteurs monophasés portent une protection thermique incorporée.

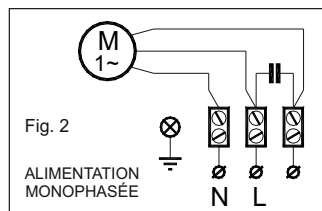
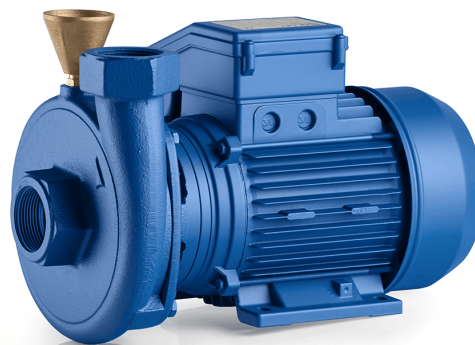

Fig. 2

MB



CE

Mode d'emploi Instructions for use and technical data



FRANÇAIS

- Dans le cas des moteurs triphasés l'utilisateur doit la fournir en se conformant aux normes d'installation en vigueur.
- Les schémas de la Fig. 3 illustrent un branchement électrique bien fait.

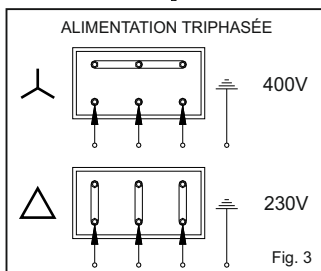

Fig. 3

6. CONTRÔLES AVANT LA PREMIÈRE MISE EN MARCHÉ:

- Vérifiez si la tension et la fréquence du réseau correspondent bien à celles indiquées sur la plaque des caractéristiques.
- Assurez-vous que l'arbre de la pompe tourne librement.
- Remplissez d'eau le corps de pompe et le tuyau d'aspiration par le bouchon de remplissage (Fig. 4), vérifiez qu'il n'y ait aucun joint ou raccord qui fuit.
- Vérifiez le sens de rotation du moteur en suivant l'indication figurant sur le corps d'aspiration.
- Dans les moteurs triphasés, si le sens de rotation est erroné inversez deux phases dans le tableau de protection.

NE FAITES JAMAIS MARCHER LA POMPE A SEC.

7. MISE EN MARCHÉ

- Ouvrez les vannes de passage existant dans les circuits d'aspiration et de refoulement.

- Vérifiez le courant et absorbé par le moteur pour la version triphasée, légez le relais thermique.

! Si le moteur ne démarre pas ou s'il n'y a pas d'extraction d'eau, reportez-vous au répertoire des éventuelles pannes et solutions pertinentes que le présent livret vous propose dans les pages qui suivent.

8. ENTRETIEN

- Nos électropompes n'ont besoin d'aucun entretien particulier. Cela étant, il est conseillé en périodes d'inactivité prolongée et de basses températures de vider le corps de la pompe. Lorsque l'inactivité se poursuit, il convient de nettoyer la pompe et de la ranger dans un endroit sec et aéré.

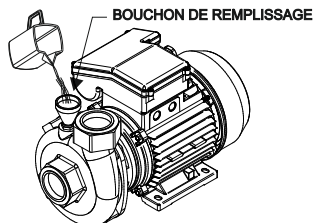

Fig. 4

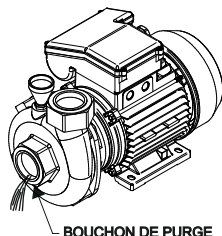

Fig. 5

FRANÇAIS

9. RECHERCHE DES PANNES

! Avant d'effectuer toute sorte d'opérations, s'assurer que l'alimentation électrique ait bien été coupée.

PANNES	CAUSES
La pompe ne démarre pas.	<ul style="list-style-type: none"> - Pas d'électricité. - Le circuit de commande est coupé ou défectueux. - Le moteur est défectueux. - La pompe est bloquée par des impuretés.
La pompe tourne mais ne débite pas d'eau.	<ul style="list-style-type: none"> - La pompe n'est pas remplie de liquide. - La tuyauterie d'aspiration ou de refoulement est bouchée par des impuretés. - La pompe est bouchée par des impuretés. - La hauteur d'aspiration est trop élevée. - La tuyauterie d'aspiration fuit. - Le clapet de retenue/pied est bloqué.
Débit et pression trop faibles.	<ul style="list-style-type: none"> - Le sens de rotation du moteur n'est pas correct (triphase). - La hauteur d'aspiration est trop élevée. - La tuyauterie d'aspiration ou de refoulement est bouchée. - La pompe est bouchée par des impuretés. - Le clapet de retenue/pied est partiellement bloqué.
La pompe déclenche lors du fonctionnement.	<ul style="list-style-type: none"> - Le rupteur thermique ou la protection moteur extérieure déclenche. - Le circuit de commande est coupé.

Si malgré tout le problème persistait consulter le centre de service le plus proche.

ENGLISH

1. GENERAL WARNINGS

- Read this manual carefully before installing this pump. It contains every necessary information for installation, correct use and maintenance of BMI/BTI pumps.

- It's very important that the user reads this manual before using the pump. Any damage caused by failure to observe the directions contained in this manual will not be covered by warranty.

! - By the time you receive this pump check if it wasn't damaged during transportation.

- In this case, please contact our agent as soon as possible.

2. OPERATING CONDITIONS:

- The BMI/BTI are centrifugal pumps and have been designed to work with clean water at a maximum temperature of 40° C.

3. INSTALLATION:

- The pump should be fixed to a solid base by bolts through the holes in the pump bracket in order to prevent unwanted noise or vibration.

! - You should place pump as near as possible to water level so to have the minimum suction lift and reduce loss of head.

- Make sure that pump is never submerged and that it rests in a dry and well aired room.

4. PIPES ASSEMBLY:

- Suction pipe (Pic. 1) must have a slightly larger diameter than the pump inlet and must always remain in an upward inclination of 2% so to help with correct priming.

- A foot valve with filter should be installed and submerged to at least 30 cm below the well dynamic level to prevent air from entering the pump.

- Be sure that discharge pipe (Pic. 1) should never rest on top of the pump.

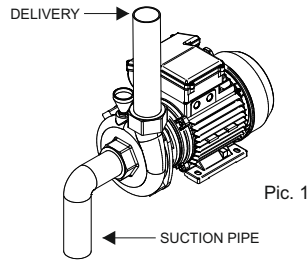

5. ELECTRICAL CONNECTION:

- The single-phase motors have a built-in thermal protection.

- The electrical installation must have a system of multiple separations with contact opening of at least 3 mm.

- The protection of the system will be based on a differential switch (I_{fn} = 30 ma).

- The electric cable must correspond to the EEC (2) norm or to the type H07 RN-F.

- With three-phase motors, end-user must install himself the correct protection to the pump as per the appropriate installation regulations.

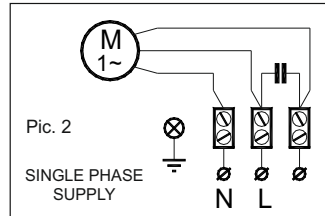

- Follow directions on Pic. 3 for a correct electrical connection.

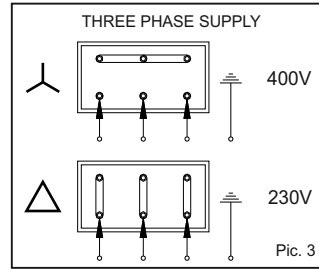

6. CONTROLS PRIOR TO THE INITIAL STARTING:

- Check that voltage and frequency correspond to those indicated on the technical characteristics label.

- Make sure the motor shaft is turning freely.

- Fill pump body completely with water, as well as the suction pipe, through the priming hole (Pic. 4). Check that there is no leaking through joints or connections.

- Check to assure that the sense of rotation of the motor coincides with that indicated on the fan cover. If you are checking threephase motor and the sense of rotation is wrong, invert two phases on the protection board.

THIS PUMP SHOULD NEVER BE DRY OPERATED.

7. STARTING

- Open all gate valves installed in the suction and discharge circuits.

- Check absorbed current and adjust thermal relay conveniently only when operating with three-phase pumps.

- If motor failed to start or did not pump water up, refer to our "Trouble Shooting" list and identify your problem. Then follow instruction on what action to take.

8. MAINTENANCE

- Our pumps do not need any special or programmed maintenance.

Pump body should, however, be drained during periods of low temperatures or long periods of inactivity. To empty pump, only remove drain plug (Pic. 5). If the inactivity persisted, pump should be cleaned and stored in a dry aired room

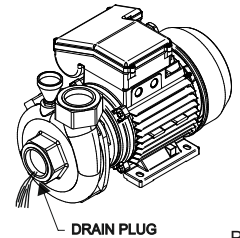
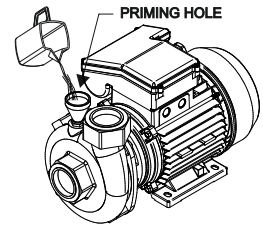

ENGLISH

9. FAULT FINDING CHART

! Before attempting to diagnose any fault, make sure that the electricity supply has been switched off.

FAULT	CAUSE
Pump does not start.	<ul style="list-style-type: none"> - Supply failure. - Control circuit has cut out or is defective. - Motor is defective. - Pump is blocked by impurities.
Pump runs but gives no water.	<ul style="list-style-type: none"> - Pump is not filled with liquid. - Suction or discharge pipe is blocked by impurities. - Pump is blocked by impurities. - Suction lift is too great. - Leakage in suction pipe. - Foot or non-return valve is blocked.
Pump runs at reduced capacity.	<ul style="list-style-type: none"> - Wrong direction of rotation (three-phase). - Suction lift is too great. - Suction or discharge pipe is blocked. - Pump is blocked by impurities. - Foot or non-return valve is partly blocked.
Pump stops during operation.	<ul style="list-style-type: none"> - Thermal overload switch in motor or external motor protection cuts out. - Control circuit has cut out.

If in spite of carrying out the above operations the problem still persists contact the nearest service centre.

The products, referred to in this statement are in accordance with Directive 73/23/EEC (the Low Voltage Directive). Full compliance with essential requirements of the Directive is verified for compliance with standard EN 60335-2-41.

Les produits, visés dans la présente déclaration sont conformes à la directive 73/23/CEE (la Directive Basse Tension). Plein respect des exigences essentielles de la directive est vérifié pour la conformité à la norme EN 60335-2-41.

Rodriguez
(Généralist)